

# R8/17...R40/17

Version: RP(+)

## **en** Assembly and Operating Instructions

### Tubular drives for roller shutters

Important information for:

- Fitters / • Electricians / • Users

Please forward accordingly!

These instructions must be kept safe for future reference.



## Table of contents

General .....	3
Warranty .....	3
Safety instructions .....	4
Instructions for the user .....	4
Instructions for installation and commissioning.....	4
Intended use .....	6
Installation.....	6
Assembling the drive .....	6
Undoing the mounting pin.....	7
Drive adapter safety catch .....	7
Assembling the drive adapter with safety catch on the drive shaft.....	7
Disassembling the drive adapter with safety catch on the drive shaft .....	7
Assembling and disassembling the drive adapter with separate drive adapter safety catch.....	8
Assembling and disassembling the drive adapter with screw connection .....	8
Securing the drive against axial displacement.....	8
Fixing the drive adapter to the barrel dia. 45 .....	8
Mounting the drive in the tube .....	9
Setting the limit positions.....	10
Deleting the limit positions using the programming unit.....	12
Upper anti-freeze mechanism .....	13
Obstruction detection / Blockage detection .....	13
Information for the electrician .....	14
Disposal .....	14
Maintenance .....	14
Technical data dia. 45 .....	14
What to do if...?.....	15
Sample wiring diagrams .....	16
Declaration of conformity .....	18

## General

These tubular drives are high-quality products with the following features:

- Ideal for use with roller shutters
- Automatic detection of limit positions thanks to intelligent electronic system with stop systems
  - Secure anti-lifting device (RP+)
  - Slight pressure applied to the roller shutter curtain makes it difficult to raise or reach under it (RP+)
  - Suitable for rigid aluminium, steel and wooden profiles
- Installation without stops possible (from upper point to lower point)
- Obstruction detection in down direction when using suspension springs (RP, RP+) and anti-lifting device (RP+)
- Blockage detection in up direction (e.g., end strip frozen to the window sill)
- The limit positions do not have to be reset: Changes in the shading solution are accommodated automatically when using stop systems.
- Drive puts the roller shutter curtain under low tensile load
- Soft upper stop
- Several drives can be operated in parallel
- Compatible with existing drives with electronic limit switching (4-core connecting cable)
- Comprehensive range of the drive manufacturer's control units can be used

Please observe these Assembly and Operating Instructions when installing and setting the equipment.



The date of manufacture comes from the first four digits of the serial number.

The numbers 1 and 2 indicate the year and the numbers 3 and 4 indicate the calendar week.

Example: 24th calendar week in 2012

Ser. No.:	1224XXXXX
-----------	-----------

### Explanation of pictograms

	<b>CAUTION</b>	CAUTION indicates a hazardous situation which, if not avoided, could result in injury.
	<b>ATTENTION</b>	ATTENTION indicates measures that must be taken to avoid damage to property.
		Denotes user tips and other useful information.

## Warranty

Structural modifications and incorrect installation which are not in accordance with these and our other instructions can result in serious injuries, e.g., crushing of limbs. Therefore, structural modifications may only be carried out with our prior approval and strictly in accordance with our instructions, particularly the information contained in these Assembly and Operating Instructions. Any further processing of the products which does not comply with their intended use is not permitted.

The end product manufacturer and fitter have to ensure that all the relevant current statutory, official and, in particular, EMC regulations are adhered to during utilisation of our products, especially with regard to end product manufacture, installation and customer advice.



## Safety instructions

The following safety instructions and warnings are intended to avert hazards and to prevent property damage and personal injury.

### Instructions for the user

#### General information

- All work, including maintenance and cleaning, on electrical installations as well as other system parts must always be performed by authorised specialists, in particular qualified electricians.
- Children from the age of 8 years and persons with reduced physical, sensory or mental capabilities or lack of experience and/or knowledge may use these devices, provided they are supervised or have been instructed in the safe use of the device, and have understood the hazards involved. Children must not play with the device.
- Systems have to be checked regularly by authorised specialists for wear and damage.
- Always put damaged systems out of operation immediately until they are repaired by an authorised specialist.
- Do not operate equipment if people or objects are within the danger zone.
- Observe the danger zone of the equipment during operation.
- Stop and disconnect the equipment from the mains power supply when maintenance and cleaning is being performed either on the system itself or in the immediate vicinity of it.
- Ensure that there is adequate clearance (at least 40 cm) between moving parts and adjacent objects.



#### Caution

#### Safety instructions for avoiding serious injuries.

- **Crushing or shearing points must be avoided or protected.**

### Instructions for installation and commissioning

#### General information

- Observe the safety instructions in EN 60335-2-97. Please note that this list of safety instructions is not exhaustive, since it would be impossible for the standard to include all sources of danger. For example, the design of the operated product, the way the drive works in the situation it is installed in or even the way the end product is mounted in the end user's place of use cannot be taken into consideration by the drive manufacturer.

If any questions or uncertainties regarding the safety instructions contained in the standard arise, please contact the manufacturer of the part or end product in question.

- All applicable standards and regulations for electrical installation must be complied with.
- All work, including maintenance and cleaning, on electrical installations as well as other system parts must always be performed by authorised specialists, in particular qualified electricians.
- Only use spare parts, tools and accessory devices which have been approved by the drive manufacturer.  
Unapproved third-party products or modifications to the system and its accessories represent a risk to your safety and the safety of others. This means that the use of unapproved third-party products, or modifications which have not been agreed with or approved by us, are prohibited. We do not accept liability for damage or injury arising from such actions.
- Position control devices within sight of the driven product, but away from moving parts, at a height of over 1.5 m.
- Permanently mounted control devices must be positioned where they can be seen.
- Rated torque and duty cycle must be suitable for the requirements of the driven product.  
Technical data – rated torque and service life can be found on the type plate of the tubular drive.

- Moving parts of drives must be installed at a height of over 2.5 m above floor level or any other surface from which access to the drive is gained.
- To ensure safe operation of the system after commissioning, the limit positions must be correctly set/programmed in.
- Drives with a H05VV-F connecting cable may only be used indoors.
- Drives with a H05RR-F, S05RN-F or 05RN-F connecting cable may be used both indoors and outdoors.
- To connect the drive to the driven part, solely mechanical accessory components made by the drive manufacturer from the current product catalogue may be used. The components must be installed in accordance with the manufacturer's instructions.
- If the drive is used for shading solutions in a specially marked area (e.g., escape routes, hazard zones, safety areas), compliance with all applicable regulations and standards must be ensured.



### **Caution**

#### **Safety instructions for avoiding serious injuries.**

- **When electrical or electronic equipment and units are operated, certain components, e.g., the power supply unit, are live. Physical injuries or damage to property can result in the event of unauthorised interventions or failure to heed warnings.**
- **Be careful when touching the tubular drive, as it heats up during operation for technological reasons.**
- **Before installation, shut down all lines and control devices that are not essential for operation.**
- **Crushing or shearing points must be avoided or protected.**
- **When installing the drive, all-pole disconnection from the mains with a contact gap of at least 3 mm per pole must be provided (EN 60335).**
- **If the mains connecting cable is damaged, it may only be replaced by the manufacturer.**

### **Attention**

#### **Safety instructions for avoiding property damage.**

- **Ensure that there is adequate clearance between moving parts and adjacent objects.**
- **The drive must not be carried by the mains connecting cable.**
- **All latching connections and fastening screws on the brackets must be checked to ensure that they are secure.**
- **Ensure that nothing rubs against the tubular drive, such as shading solution attachments, screws, etc.**



## Intended use

The type of tubular drive described in these instructions is intended solely for the operation of roller shutters.

This type of tubular drive supports not only curtain attachment by means of springs but also mechanical anti-lifting devices (e.g., Zurfluh-Feller, Simu, GAH Alberts and Deprat). These are detected automatically.

If the springs or the top lath are rigidly connected to the barrel (screwed, rivetted, etc.), please use only the tubular drive type RP, as the RP+ drive could detect this as an anti-lifting device and could damage parts of the system.

For sun protection applications, please use only the types of tubular drive designed for this purpose.

This type of tubular drive is designed for use in single systems (one drive per barrel).

The tubular drive must not be used in potentially explosive areas.

The connecting cable is not suitable for transporting the drive. Always carry the drive by the housing tube.

Other applications, uses and modifications are not permitted in order to protect the safety of the users and others, since these actions can impair the system's safety and carry the risk of personal injury and property damage. The drive manufacturer does not accept liability for damages or injury arising from such actions.

Always observe the information in these instructions when operating or repairing the system. The drive manufacturer does not accept liability for damage or injury resulting from improper usage.

### Attention

**Only use anti-lifting devices if the roller shutter laths are sufficiently strong. The closed curtain must not project beyond the guide tracks or else there is a risk of the joint between the top two laths being subjected to excessive strain and getting damaged.**

## Installation

### Assembling the drive

#### Attention

**To connect the drive to the driven part, solely mechanical accessory components made by the drive manufacturer from the current product catalogue may be used.**

Prior to mounting, the fitter must ensure that the masonry and the system being motorised are sufficiently robust (drive torque plus weight of the shading solution).



#### Caution

**Electrical connections may only be carried out by a qualified electrician. Prior to assembly, the power supply must be disconnected and secured. Please give the enclosed connection information to the responsible electrical contractor.**

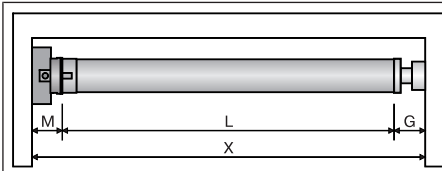

Calculate the space required at the side (M) by measuring the drive head and wall bracket. The clear dimension of the box (X) minus the space required at the side (M) and idler (G) gives the length (L) of the barrel:  $L=X-M-G$ .

The space required at the side (M) varies depending on the combination of drive and wall bracket.

Then mount the wall bracket and idler. Ensure that the barrel is aligned at right angles to the wall and that sufficient axial play is allowed for the mounted system.

#### Attention

**When using rigid shaft connectors, closed brackets must be fitted. The tubular drive presses the closed curtain down to make it difficult for people to reach under it or raise it. Only use curtains made of sufficiently strong material, such as aluminium, steel or wood. To prevent damage to the curtain it must run in guide tracks from top to bottom.**

## Undoing the mounting pin

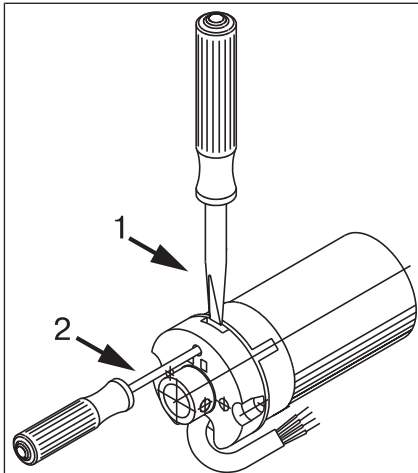

When pushed in, the mounting pin locks automatically. To undo the mounting pin, either insert the screwdriver, max. dia. 2.5 mm, (2) into the hole and push upwards, or push a flat-head screwdriver with a width of approx. 8mm (1) into the groove.

## Drive adapter safety catch

### Assembling the drive adapter with safety catch on the drive shaft

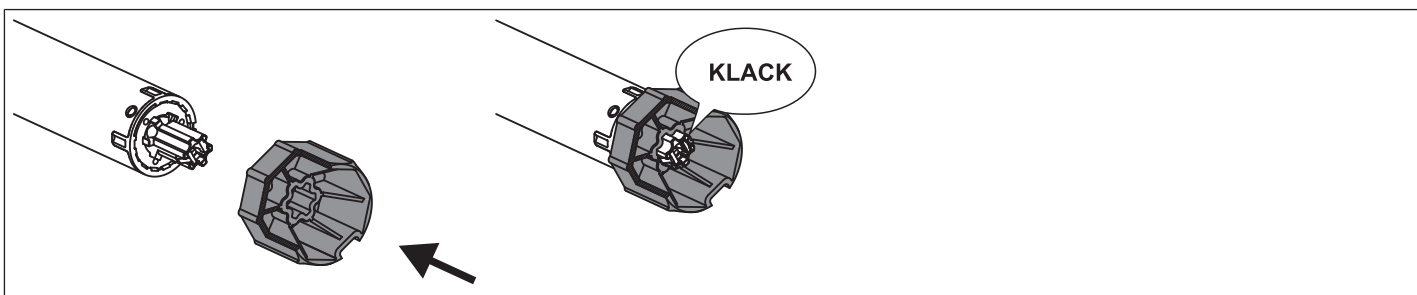

### Disassembling the drive adapter with safety catch on the drive shaft

Disassembly with disassembly tool, Item no. 4930 300 606 0

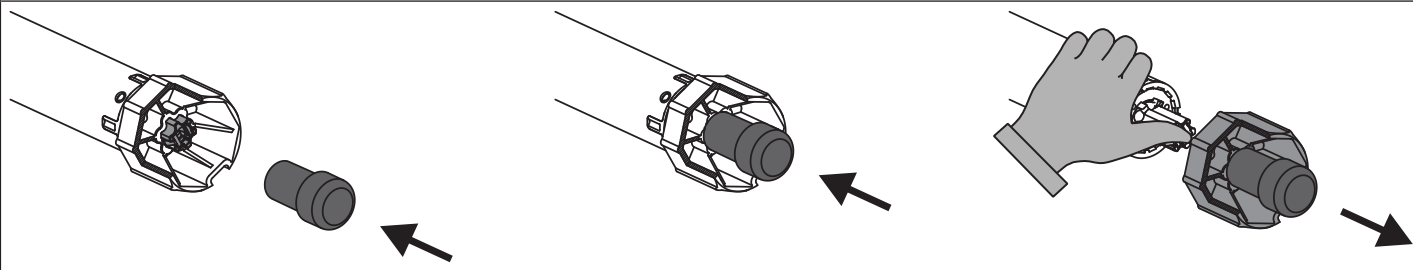

Disassembly with long nose pliers

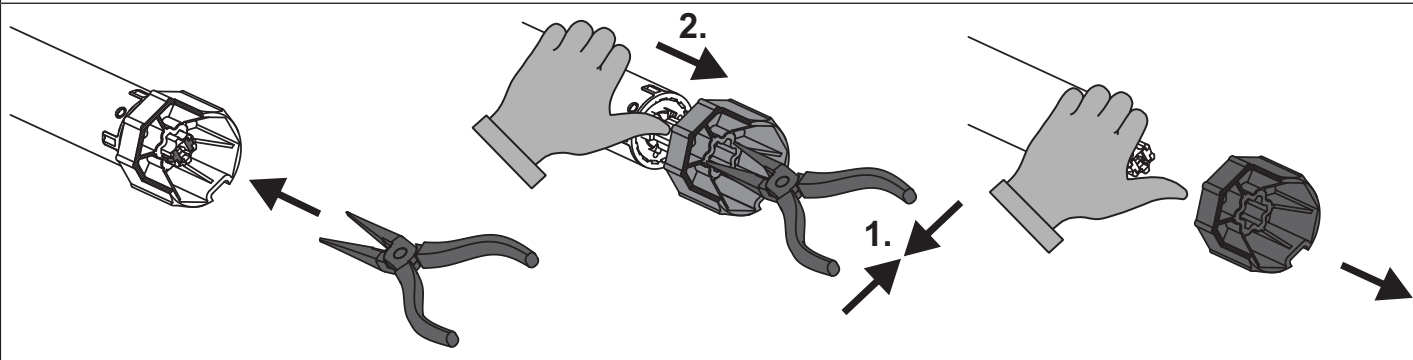

### Assembling and disassembling the drive adapter with separate drive adapter safety catch

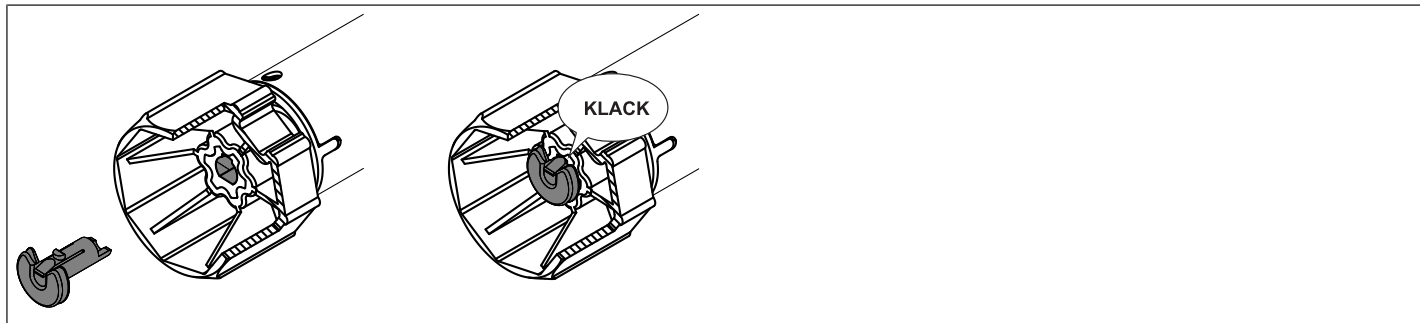

### Assembling and disassembling the drive adapter with screw connection

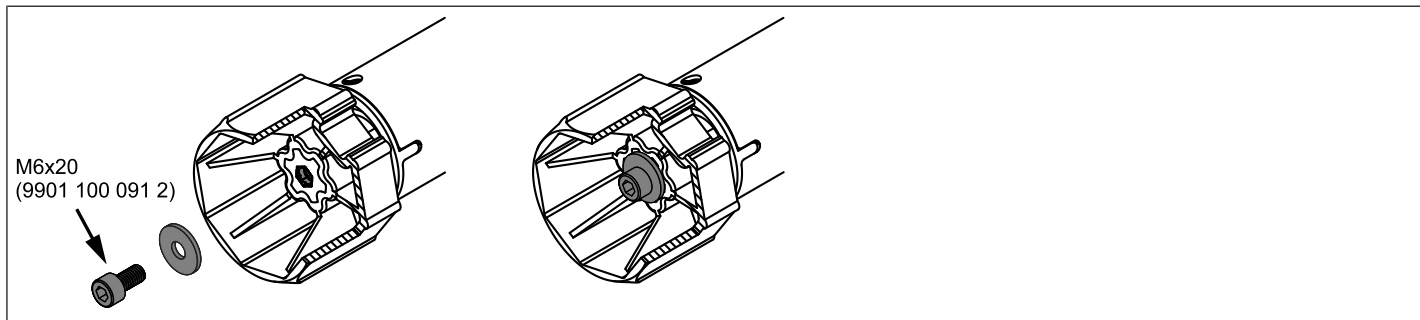

### Securing the drive against axial displacement

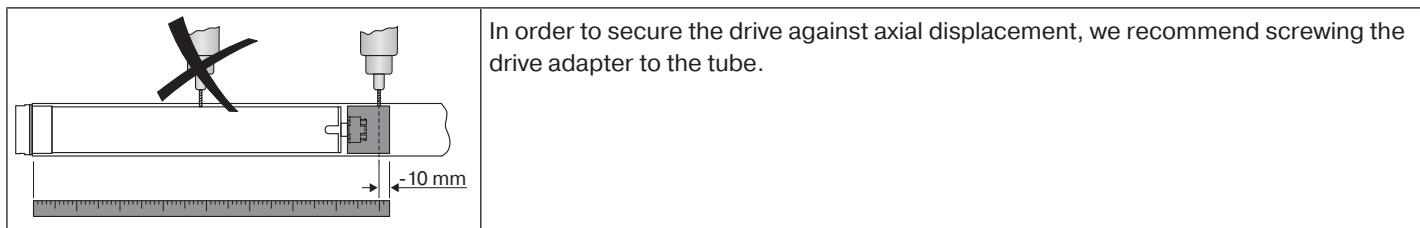

In order to secure the drive against axial displacement, we recommend screwing the drive adapter to the tube.

#### Attention

**When drilling into the barrel, never drill near the tubular drive!**

### Fixing the drive adapter to the barrel dia. 45

Size of drive [mm]	Diameter of barrel [mm]	Torque max. [Nm]	Fastening screws for drive adapter (4 pc.)
dia. 45	50 - 70 mm plastic drive adapter	25	Self-tapping screw dia. 4.8 x 9.5 mm
dia. 45	50 - 85 mm plastic drive adapter for obstacle detection	40	Self-tapping screw dia. 4.8 x 9.5 mm
dia. 45	50 - 85 mm diecast drive adapter	50	Self-tapping screw dia. 4.8 x 9.5 mm

We also recommend screwing the idler to the barrel.

#### Attention

**Do not hammer the tubular drive into the tube or drop it into the barrel! The curtain can only be secured using springs or rigid shaft connectors.**



## Mounting the drive in the tube

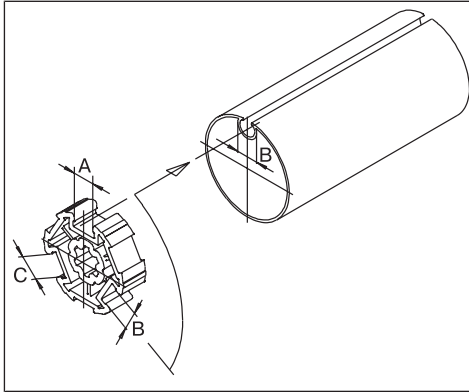

### For profile tubes:

In the case of some drive adapters, tolerances of the groove widths in different barrels can be offset by rotating the drive adapter into a different groove recess. These groove recesses have different sizes and allow the drive to fit exactly.

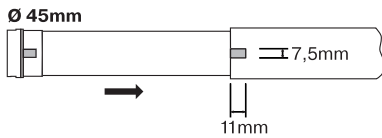

### For round tubes:

First notch the tube on the motor side, so the lug of the thrust ring can also be pushed into the tube. There must be no play between the lug of the thrust ring and the tube. For rings without drive lugs, which are used to assist fitting on the thrust ring, the barrel must be connected to the thrust ring by a 4.8 x 9.5 mm self-tapping screw.

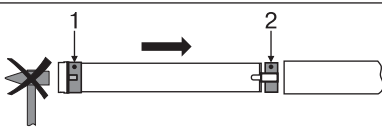

Assemble the tubular drive with the relevant thrust ring (1) and drive adapter (2). Insert the tubular drive with the pre-assembled thrust ring and drive adapter into the tube to achieve a form fit. Ensure that the thrust ring and drive adapter are secure in the tube.

Mount the assembled unit comprising barrel, tubular drive and idler on the box and secure the drive according to the type of wall bracket fixing with a split or spring pin.

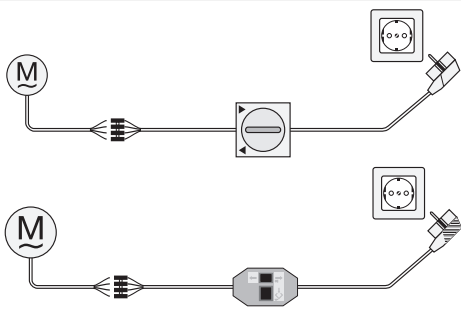

Automatic setting of limit positions is possible, where a stop system is present on both sides, using the switch (Item no. 4901 001 158 0), a standard rotary switch or the programming unit for drives with electronic limit switching (Item no. 4935 200 011 0). All other functions can only be set via the programming unit.

Connect the wires of the tubular drive to those of the same colour in the programming/operator control and switch on the power supply.



**The switch and the programming unit are only meant for the commissioning, not for continuous operation!**

Position the barrel so that the roller shutter curtain can be attached with springs or fit the rigid shaft connectors in accordance with the manufacturer's instructions.

### Attention

**The switch and the programming unit are only meant for the commissioning, not for continuous operation!**



**When using springs/anti-lifting devices, we recommend you use at least three; for longer tubes, use three springs/anti-lifting devices per meter of barrel.**

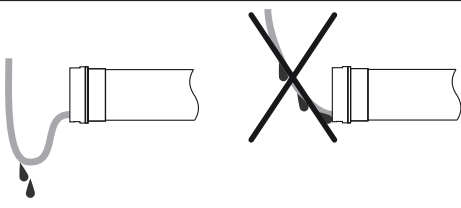

### Lay the connecting cable

Lay the connecting cable up to the tubular drive, and fix The connecting cable and any antennae must not project into the winding chamber. Cover any sharp edges.



## Setting the limit positions

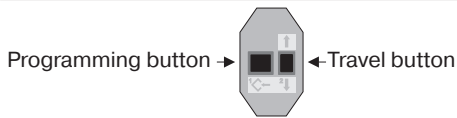

Programming unit for drives with electronic limit switching.

### Attention

**The programming unit is only designed for the commissioning, not for continuous operation.**

## Intelligent installation management

### Limit position status indicator

A brief stopping and restarting indicates that no limit position has been set in that direction of movement.

### Completion of installation following automatic setting of limit position "Stop"

The drive saves the limit position "Stop" permanently once the it has been reached 3 times in succession. Installation is then complete.

### There are 4 ways to set the limit positions:

- Upper stop to lower stop
- Upper point to lower point
- Upper stop to lower point
- Upper point to lower stop

The limit position becomes fixed after the tubular drive has turned off automatically in the desired position three times.



**If the tubular drive switches off prematurely while opening or closing, due to an obstruction, the obstruction can be cleared by reversing a short way and removing the obstruction. The desired limit position can be set by opening/closing again.**

**When first installing, using springs and adjusting the limit position '...to lower stop', the barrel in the lower limit position turns approx. 1/4 of a turn further than usual. In doing so, the tubular drive is able to automatically detect the use of anti-lifting devices or springs. The tubular drive switches off automatically. Type and source of the risk**

### Upper stop to lower stop

	<p>Open to the permanent upper stop.</p> <ul style="list-style-type: none"> <li>▸ The tubular drive switches off automatically.</li> </ul>
	<p>Then close to the permanent lower stop.</p> <ul style="list-style-type: none"> <li>▸ The tubular drive switches off automatically.</li> <li>▸ The limit positions are now set.</li> </ul>

## Upper point to lower point



**There is no shading solution length adjustment with this limit position setting.**

		<p>Open to the desired upper limit position.</p>
		<p>Press the programming button of the programming unit for 3 seconds.</p> <ul style="list-style-type: none"> <li>▸ The tubular drive makes a “click” sound to confirm.</li> </ul>
		<p>Then close to the desired lower limit position.</p>
		<p>Press the programming button of the programming unit for 3 seconds.</p> <ul style="list-style-type: none"> <li>▸ The tubular drive makes a “click” sound to confirm.</li> <li>▶ The limit positions are now set.</li> </ul>

## Upper stop to lower point

		<p>Open to the permanent upper stop.</p> <ul style="list-style-type: none"> <li>▸ The tubular drive switches off automatically.</li> </ul>
		<p>Then close to the desired lower limit position.</p>
		<p>Press the programming button of the programming unit for 3 seconds.</p> <ul style="list-style-type: none"> <li>▸ The tubular drive makes a “click” sound to confirm.</li> <li>▶ The limit positions are now set.</li> </ul>





## Upper point to lower stop

		<p>Open to the desired upper limit position.</p>
		<p>Press the programming button of the programming unit for 3 seconds.</p> <ul style="list-style-type: none"> <li>▸ The tubular drive makes a “click” sound to confirm.</li> </ul>
		<p>Then close to the permanent lower stop.</p> <ul style="list-style-type: none"> <li>▸ The tubular drive switches off automatically.</li> <li>▶ The limit positions are now set.</li> </ul>

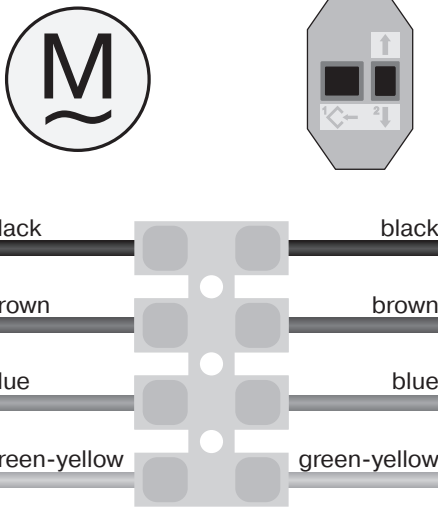
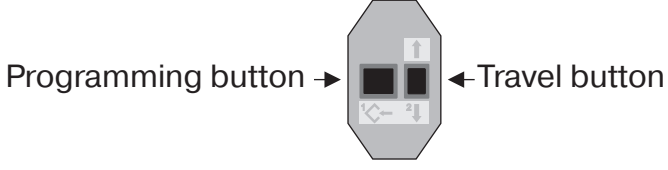
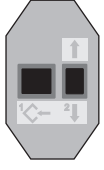

## Deleting the limit positions using the programming unit

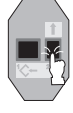
**i** Connect the wires of the tubular drive to those of the same colour in the programming unit and switch on the power supply.  
Please pause for 1 sec after the last drive command before beginning the deletion sequence. Also leave a pause of 1 sec between the individual steps of the deletion sequence.

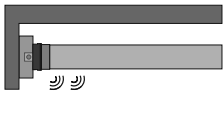
 <p>The diagram shows a motor symbol 'M' with a wavy line below it. To its right is a terminal block with four terminals. Wires connect the terminals as follows: black to black, brown to brown, blue to blue, and green-yellow to green-yellow.</p>	 <p style="text-align: center;">Programming button →  ← Travel button</p>
	<p>Press the programming button and keep it pressed.</p>
	<p>Then press down the travel button and keep it pressed.</p>
	<p>Now release the programming button, but continue to keep the travel button pressed.</p>
 	<p>Next press the programming button again.</p> <ul style="list-style-type: none"> <li>▶ The tubular drive makes a "click click" sound to confirm.</li> <li>▶ Both limit positions are deleted.</li> </ul>

## Upper anti-freeze mechanism

The upper anti-freeze mechanism helps to prevent the roller shutter from freezing in the upper limit position, as the roller shutter stops just before the upper stop. The distance from the upper stop is automatically cyclically checked and, if necessary, corrected.

The upper anti-freeze mechanism is deactivated on delivery.

Both limit positions must be set before the anti-freeze mechanism can be activated.



**The anti-freeze mechanism only works if a permanent stop is set at the upper limit position of the roller shutter. The anti-freeze mechanism is not visible until the shading solution has reached the upper stop from the lower limit position 3 times in succession. When both or individual limit positions are deleted, this set function is deleted as well.**



Open/close the shading solution to a point between the limit positions.

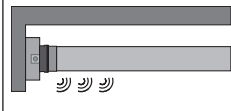

To activate the upper anti-freeze mechanism, press the programming button on the programming unit until (approx 10 s) the tubular drive clicks 3 times.

If you want to deactivate the upper anti-freeze mechanism, you must delete and reset the two limit positions.

## Obstruction detection / Blockage detection



### Caution

**Use of the drive's obstacle detection system as personal protection is not permitted. It has been designed exclusively to protect the roller shutters or sun protection system from being damaged.**

If the drive is correctly installed, it switches off when it detects obstructions or shutter faults.

The following are detected both when using attachment springs and when using anti-lifting devices:

#### In the DOWN direction (Obstruction detection)

A curtain jam when closing due to objects on the window sill or sticking of the lateral guide tracks.

#### In the UP direction (Blockage detection)

Extremely large increase in the load (e.g., frozen end strip on the window sill)

To avoid overly sudden deactivation during closing, the drive only responds to an obstruction one or two revolutions after the impact.



## Information for the electrician

Tubular drives with electronic limit switching can be connected in parallel. The maximum switching contact load of the switching equipment (timer, relay control, switch, etc.) must be observed. To operate drives with electronic limit switching, only use switching elements (timers) that are **not** earthed via the drive. The outputs of the switching element must be potential-free in the neutral position.

Use external conductor L1 to control the up and down direction. Other devices or consumers (lamps, relays, etc.) must not be directly connected to the drive connecting cables. For this purpose, the drives and additional devices must be decoupled by relay controls.

When installing the drive, all-pole disconnection from the mains with a contact gap of at least 3 mm per pole must be provided (EN 60335).

### Attention

**Only use mechanically or electrically locked switching elements with a marked zero position! This also applies when drives with electronic and mechanical limit switching are used in the same system. The changeover time for switching the running direction must be at least 0.5 s. The switch and control must not execute simultaneous UP and DOWN commands. Protect the electrical connections from damp.**

**Once you have finished wiring everything to the control, ALWAYS check the right direction assignment of the drive to the control buttons UP and DOWN, EXTEND and RETRACT.**

**If the drive is to be operated with devices which contain sources of interference, the electrician must ensure suitable interference suppression for the relevant devices.**

## Disposal

This product is made of various materials which must be disposed of properly. Find out about the applicable regulations on recycling or disposal for this product in your country.

The packaging material must be disposed of properly.

## Maintenance

These drives are maintenance-free.

## Technical data dia. 45

Type	R8/17RP(+)	R12/17RP(+)	R20/17RP(+)	R30/17RP	R40/17RP
Rated torque [Nm]	8	12	20	30	40
Output speed [rpm]	17				
Limit switch range	64 revolutions				
Supply voltage	230 V AC / 50 Hz				
Connected load [W]	100	110	160	205	260
Rated current consumption [A]	0.45	0.50	0.75	0.90	1.15
Mode	S2 4 min				
Degree of protection	IP 44				
Min. tube inside diameter [mm]	47				
Emission sound pressure level [dB(A)]	≤ 70				

## What to do if...?

Problem	Cause	Remedy
The roller shutter curtain is raised unevenly or not at all.	<ol style="list-style-type: none"> <li>1. One or more attachments have broken off.</li> <li>2. Lath has broken off.</li> </ol>	Repair system; then re-program limit positions.
Tubular drive overruns the upper limit position	Stops have broken off	Repair system; delete limit positions, then re-program limit positions
Tubular drive overruns the lower limit position. Noises can be heard	One or more attachments have broken	Repair system; delete limit positions, then re-program limit positions
Tubular drive overruns the limit position or does not reach the set limit position.	A short circuit caused by dampness.	Repair electrical installation; re-program limit positions.
	External devices are connected to the connecting cables of the tubular drive.	Check electrical installation; remove any external devices; re-program limit positions
	Due to long cable, L1 and N connection have been reversed.	Change around L1 and N (N = blue, L1 = black/brown); re-program limit positions
Tubular drive stops arbitrarily; cannot be restarted in the same direction.	Tubular drive is overloaded.	Use a more powerful tubular drive.
	Roller shutter curtain keeps sticking; too much friction.	Repair system; delete limit positions, then re-program limit positions
	The tubular drive has detected an increase in load.	Ensure that nothing rubs against the tubular drive, such as shading solution attachments, screws, etc.
Tubular drive does not run in the right direction.	Tubular drive is overheated.	The tubular drive is operational again after a few minutes.
	Tubular drive switched off the last time it went in that direction because of an obstruction.	Clear and remove the obstruction and set the drive in the direction required.
	Electrical connection faulty.	Check the electrical connection.
When opening, the drive stops short of the programmed limit position.	<p>Upper anti-freeze mechanism activated.</p> <p>The roller shutter only opens to the upper stop once every 32 times.</p>	Deactive the upper anti-freeze mechanism.



## Sample wiring diagrams



The assignment of the black and brown wires according to the direction of travel is dependant on how the drive is installed (mounted to the right or to the left).

### Controlling one/several drive(s) via a single switch/button

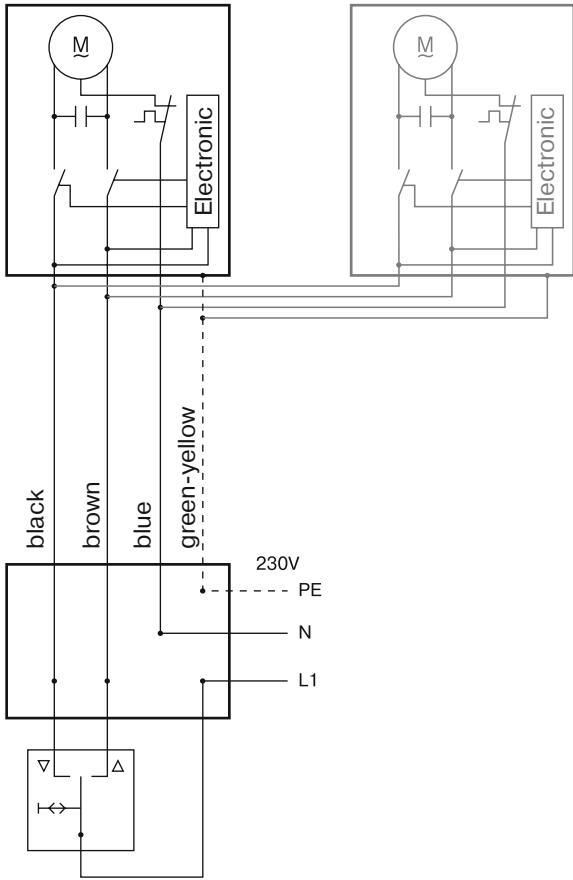



# Central, group and individual control using Centronic UnitControl UC42

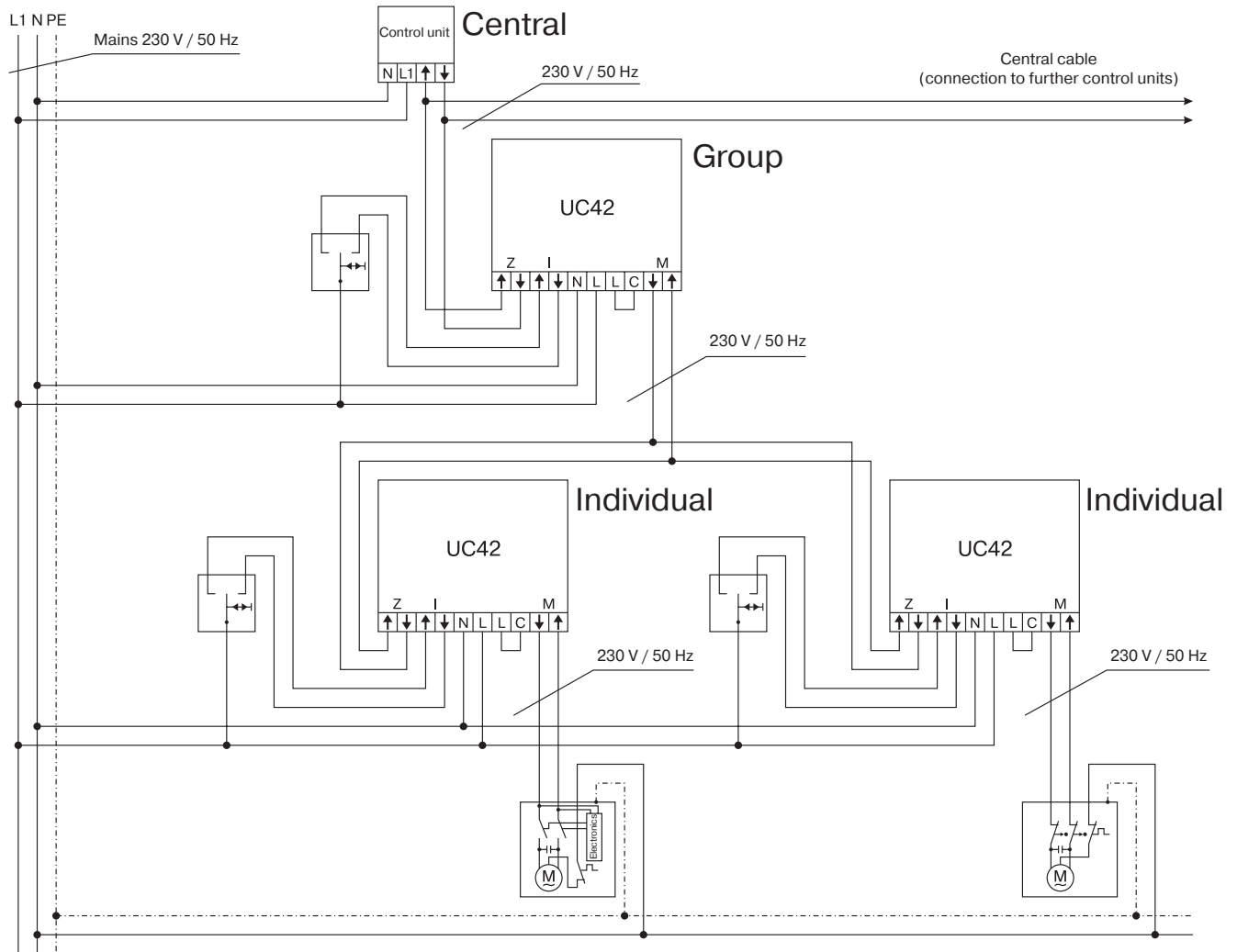

# Declaration of conformity

BECKER-ANTRIEBE GMBH  
Friedrich-Ebert-Str. 2-4  
35764 Sinn, Germany



**BECKER**

- Original -

## EU Declaration of Conformity

Document No./Month . Year: **K001/05.16**

We hereby declare that the following product series

Product designation: **Tubular motor**

Type designation: **R4/17.., R8/17.., R12/17.., R15/17.., R20/17.., R25/17.., R30/17..,  
R40/17.., R50/11.., R40/17.. (37 Nm), R7/17..,  
P9/16.., P5/30.., P5/20.., P13/9.., P5/16.., P4/16.., P3/30..,  
L44/14.., L50/11.., L50/17.., L60/11.., L60/17.., L70/17.., L80/11..,  
L80/17.., L100/11.., L120/11..**

Version: **C, M, HK, R, S, F, P, E, O, SMI, A0...Z9, mute, +**

From serial number: **from 161800001**

complies with the applicable regulations of the following Directives:

**Directive 2006/42/EC (MD)**

**Directive 2014/30/EU (EMC)**

**Directive 2011/65/EU (RoHS)**

Furthermore, the safety objectives of the **Low Voltage Directive 2014/35/EU** as per Appendix I No.1.5.1 of Directive 2006/42/EC have been met.

Applied standards:

**EN 60335-1:2014**  
**EN 60335-2-97:2015**  
**EN 61000-6-1:2007**  
**EN 61000-6-3:2011**  
**EN 14202:2004**

Authorised party for the compilation of the technical documentation:  
Becker-Antriebe GmbH, Friedrich-Ebert-Str. 2-4, 35764 Sinn, Germany

This declaration of conformity was issued:

Sinn, 29.04.2016  
Place, Date

Dipl.-Ing. Dieter Fuchs, Management

This declaration certifies compliance with the Directives cited but does not represent any assurance of characteristics.

The safety warnings in the supplied product documentation must be observed!



